

ELEVATION VIEW

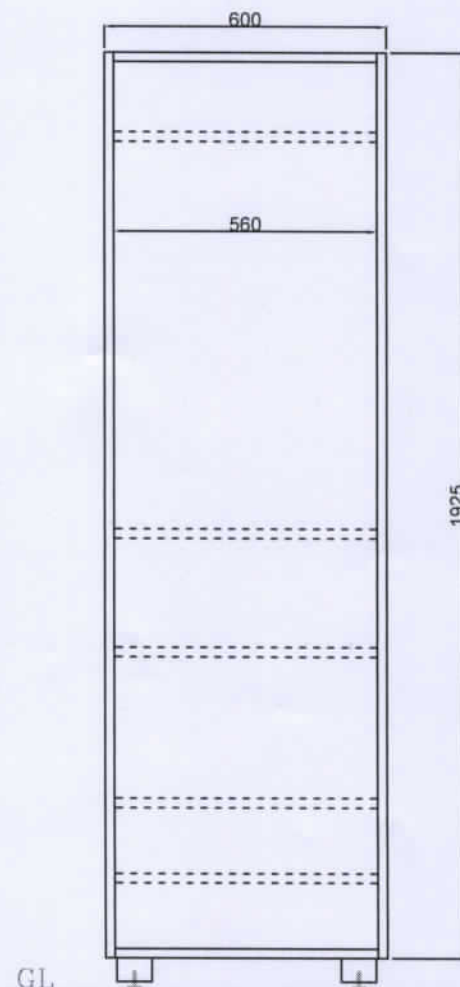

END VIEW

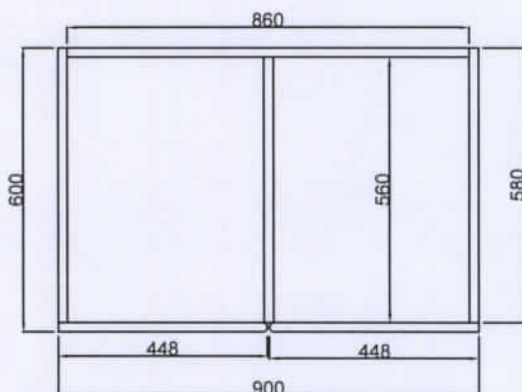

PLAN VIEW

WARDROBE SIZE:- (2000HX900WX2600D) TO BE MADE OF 20 THICK WATER-PROOF PLY WOOD WITH WHITE 0.6 LAMINATE ON BOTH SIDES OR 20 THICK PRE-LAMINATED BOARDS WHITE

SHUTTERS TO HAVE MEETING EDGES POST-FORMED (BAVARIAN BIRCH 0.63mm LAMINATE)

# WARDROBE A

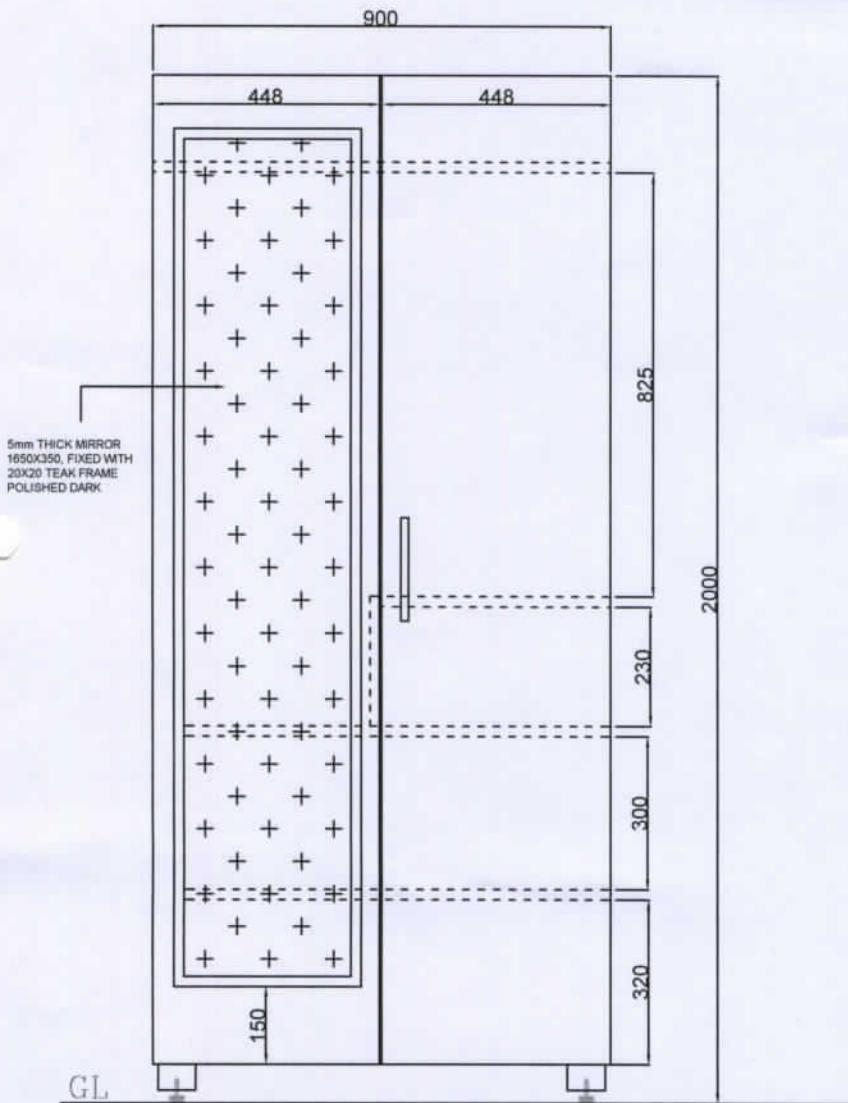

ELEVATION VIEW

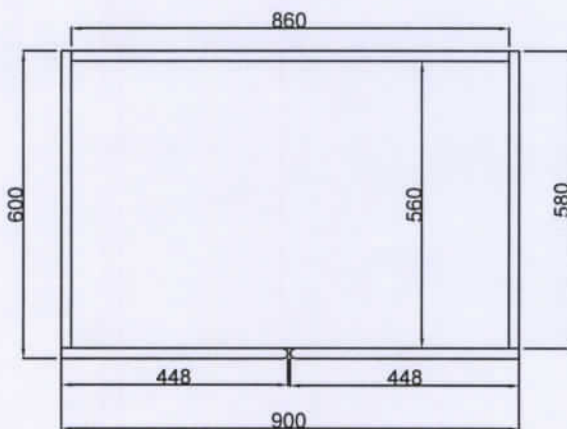

PLAN VIEW

WARDROBE SIZE:- (2000HX900WX2600D) TO BE MADE OF 20 THICK WATER-PROOF PLY WOOD WITH WHITE 0.6 LAMINATE ON BOTH SIDES OR 20 THICK PRE-LAMINATED BOARDS WHITE

SHUTTERS TO HAVE MEETING EDGES POST-FORMED (BAVARIAN BIRCH 0.6mm LAMINATE)

5mm THICK MIRROR 1650(H)X350(W), FIXED WITH 20X20 TEAK FRAME POLISHED DARK.

WARDROBE B



ELEVATION VIEW

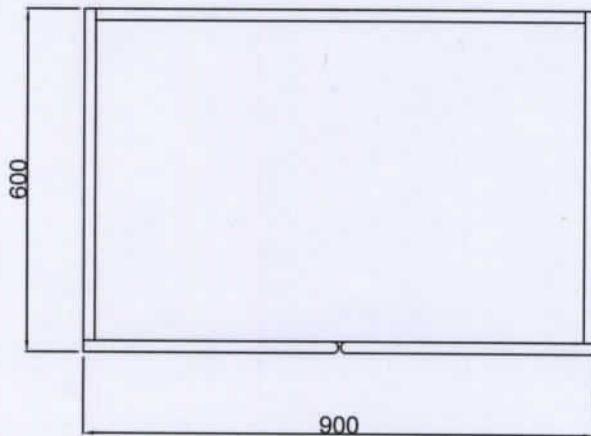

PLAN VIEW

WARDROBE A

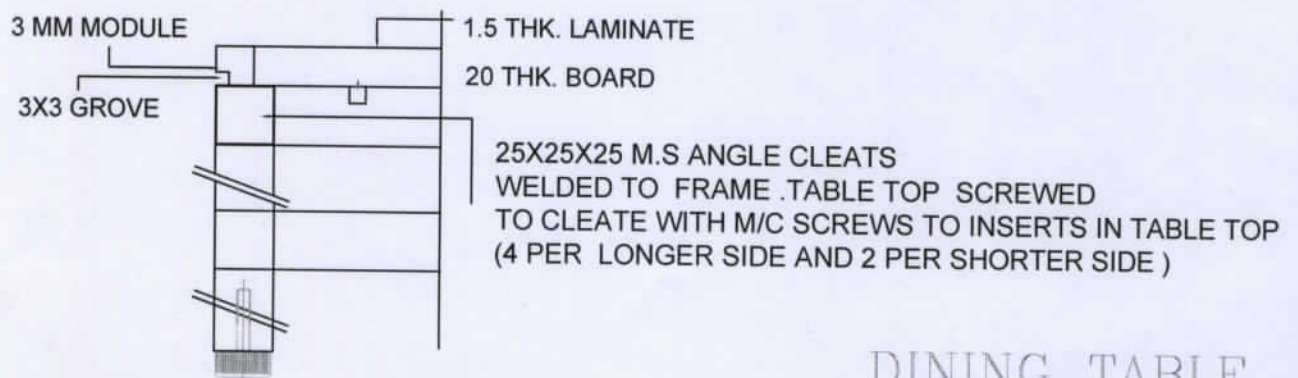
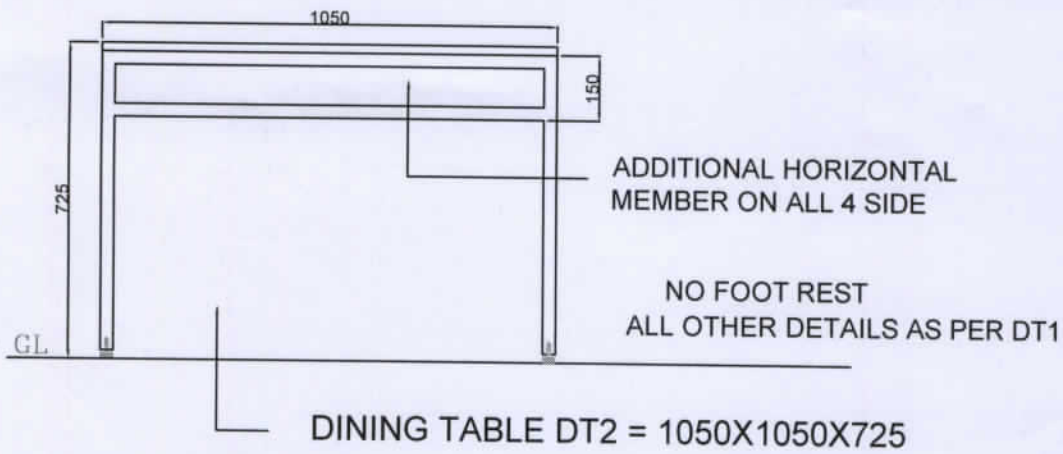
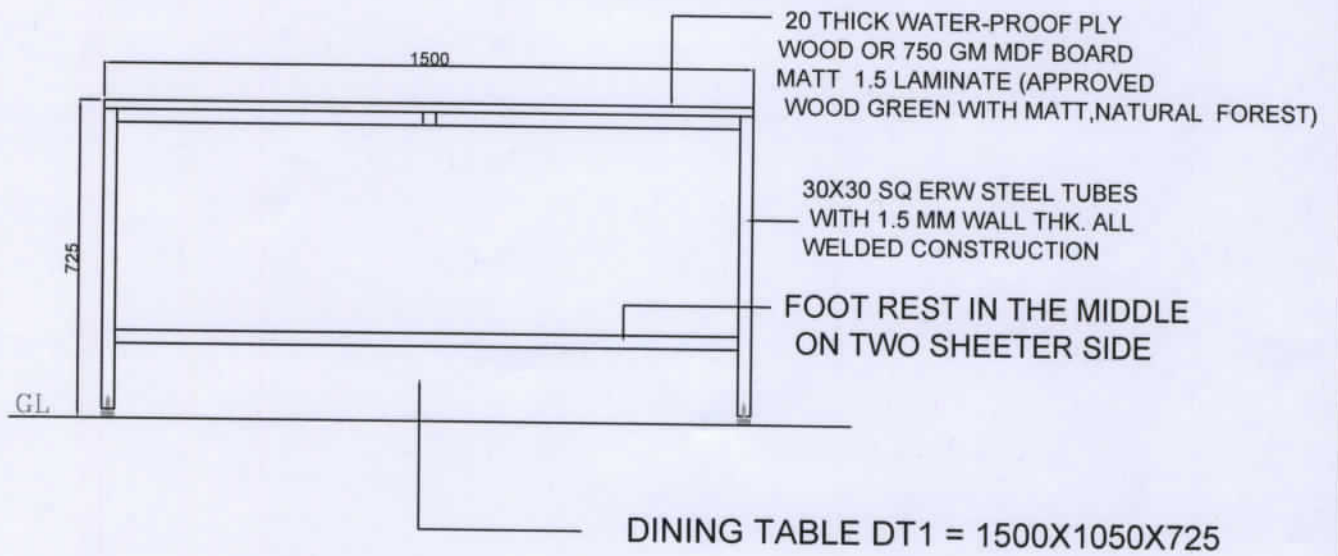

DINING TABLE

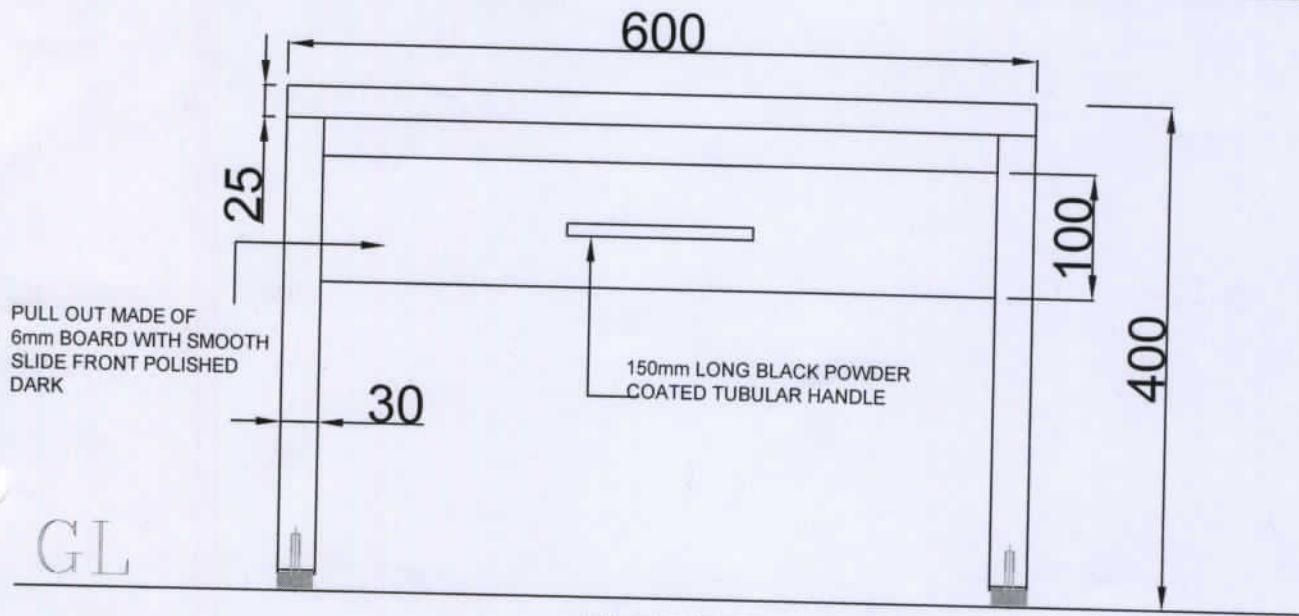

ELEVATION VIEW

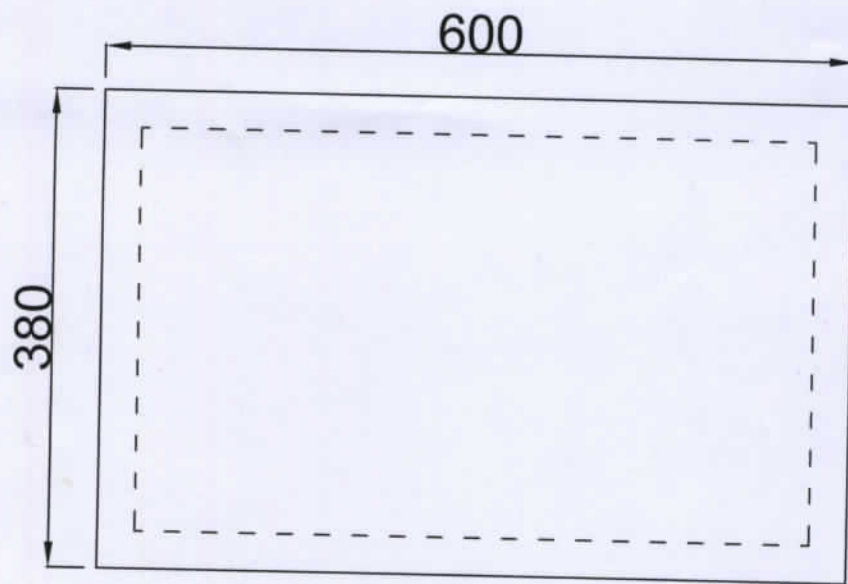

PLAN VIEW

SIDE TABLE

BASE BOARD FOR MATTRESSES  
OUT OF 12mm PLYWOOD WHICH  
WILL BE LEVEL WITH  
SIDE PANEL & TAILBOARD

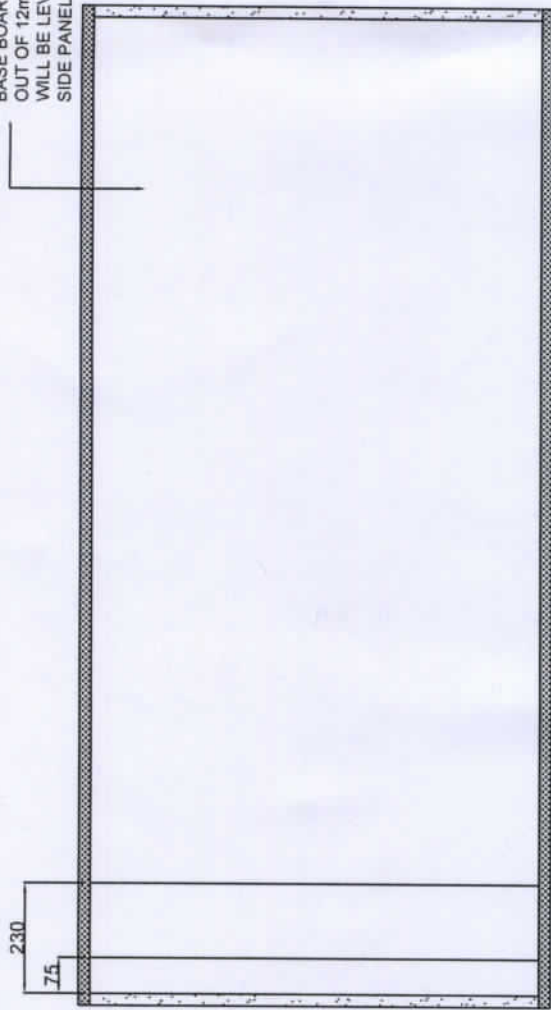

PLAN VIEW

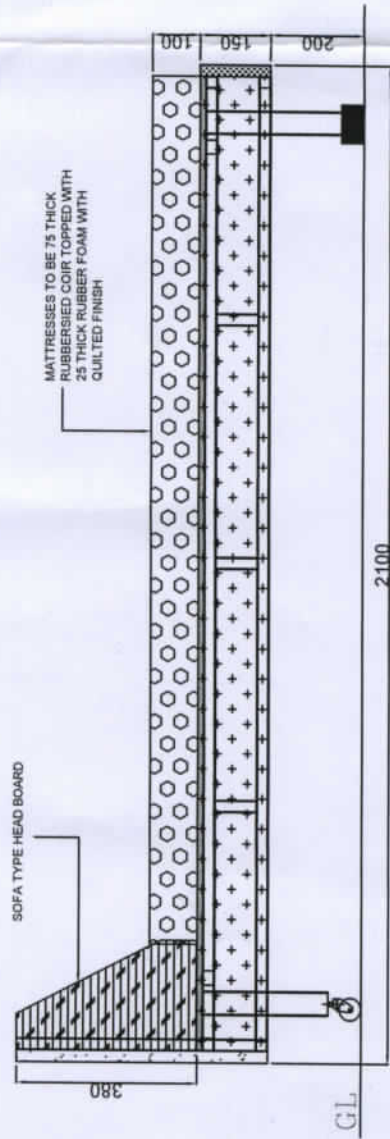

ELEVATION VIEW

BED

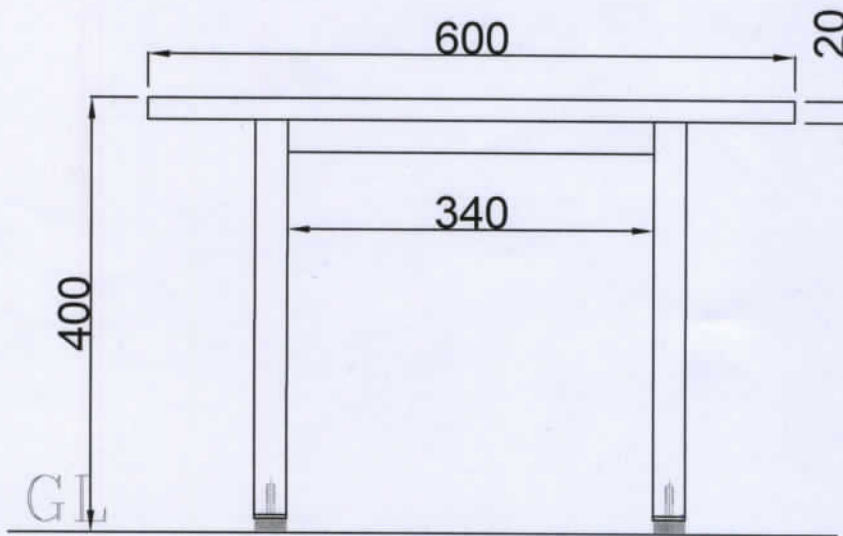

ELEVATION VIEW

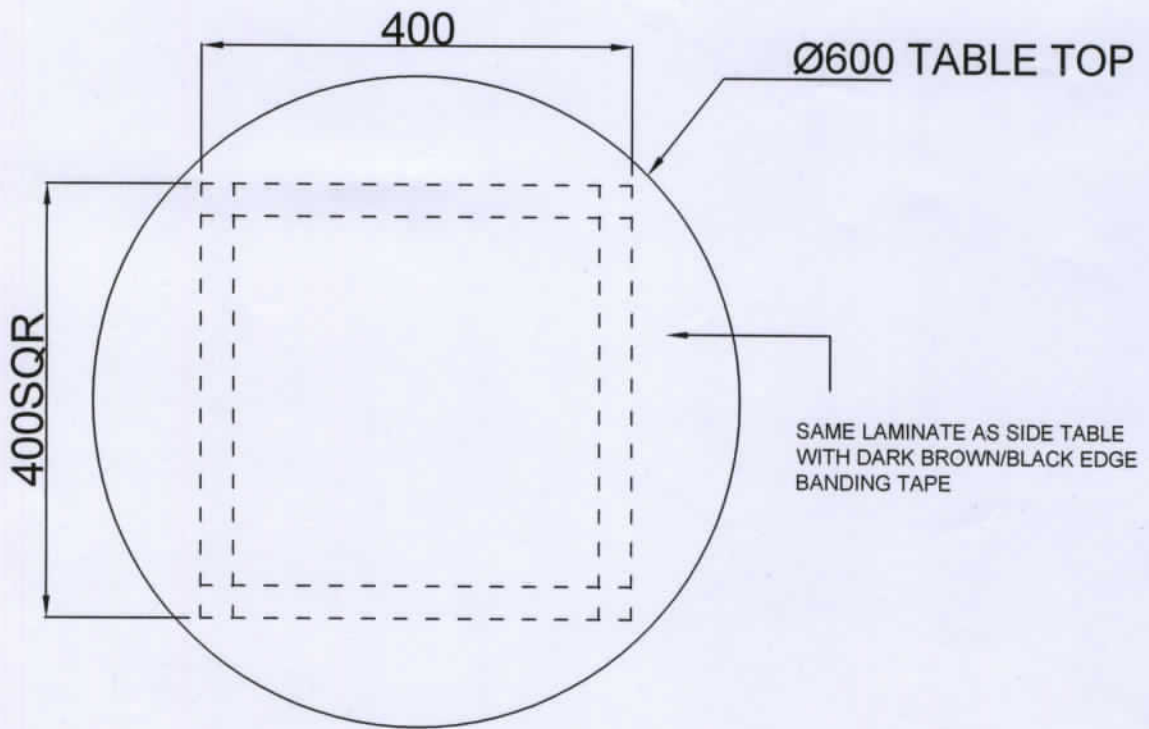

PLAN VIEW

COFFE TABLE

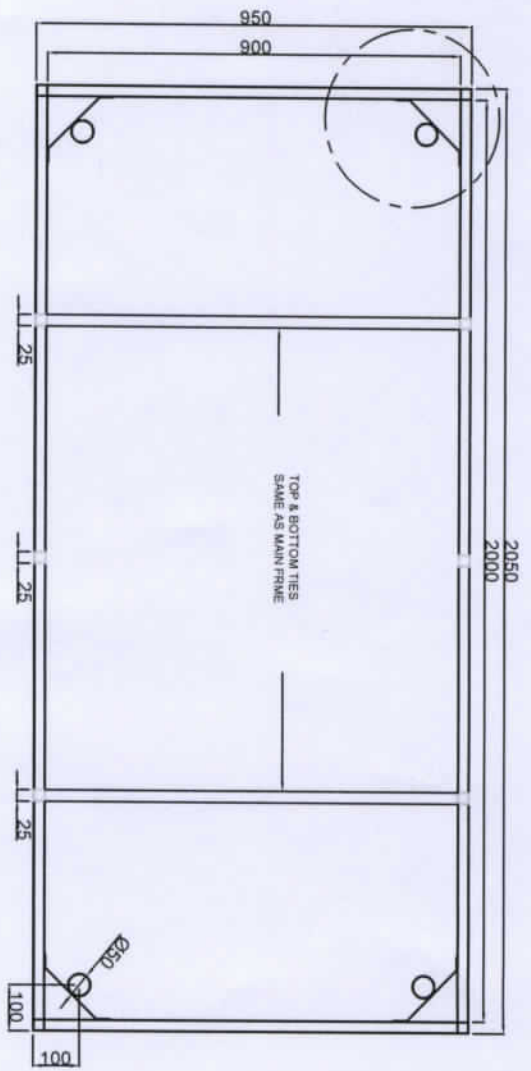

PLAN VIEW

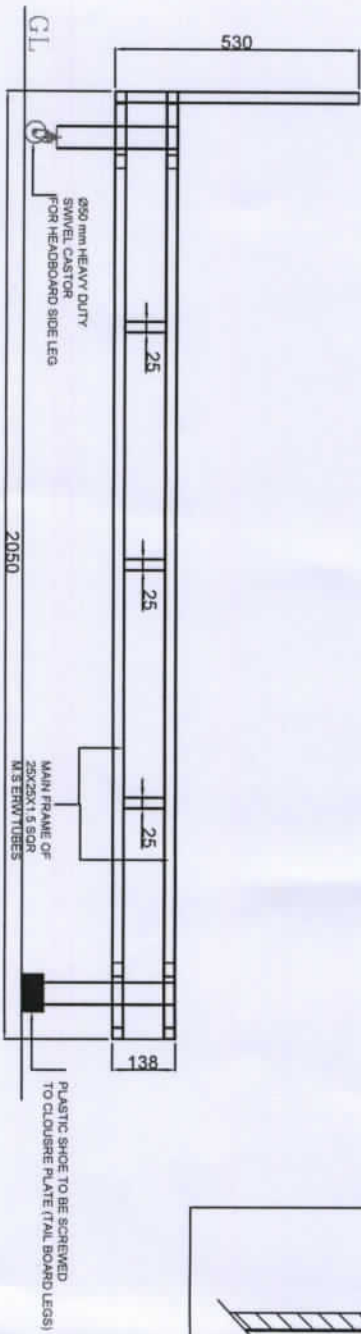

ELEVATION VIEW

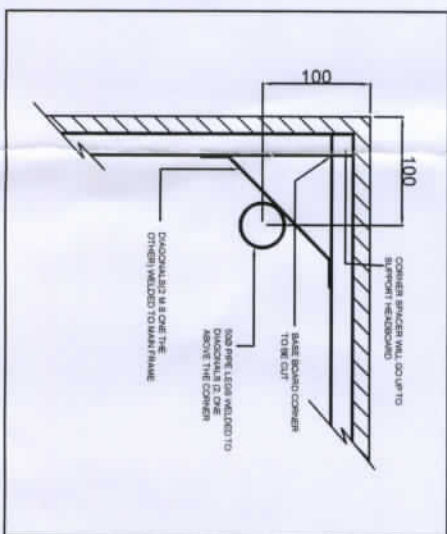

BED FRAME



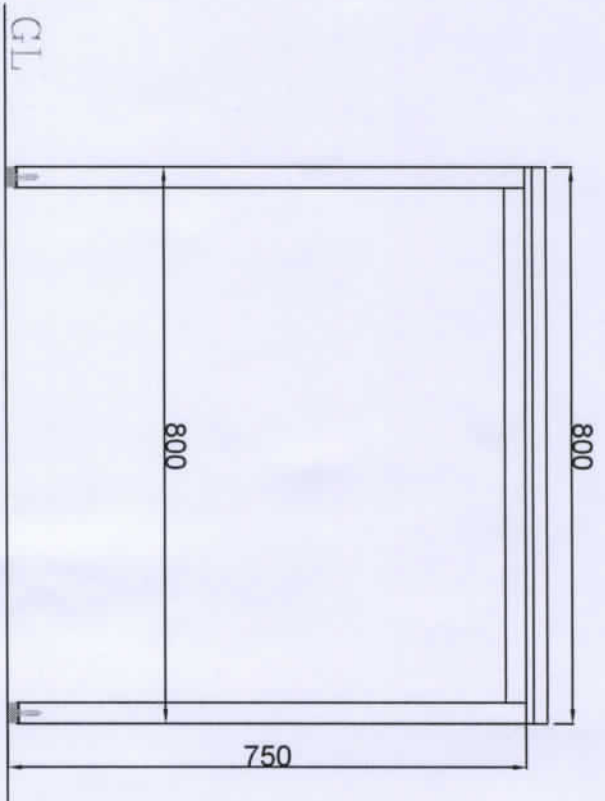

ELEVATION VIEW

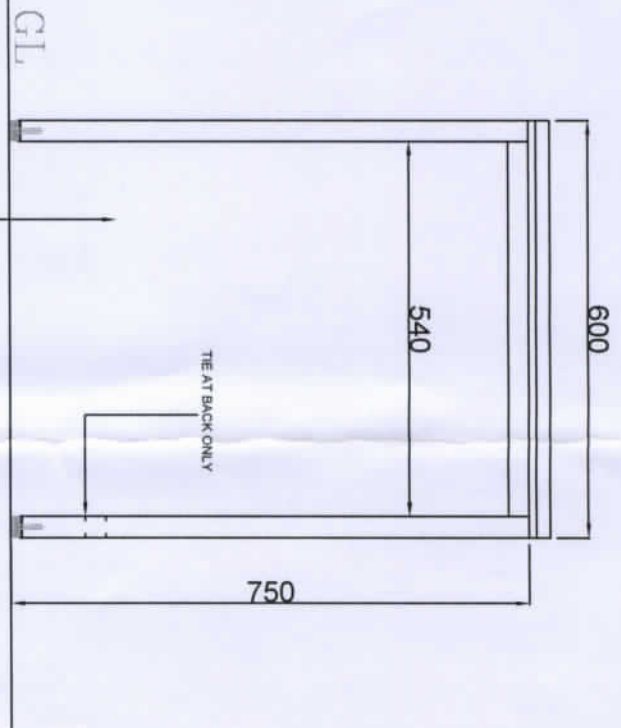

END VIEW

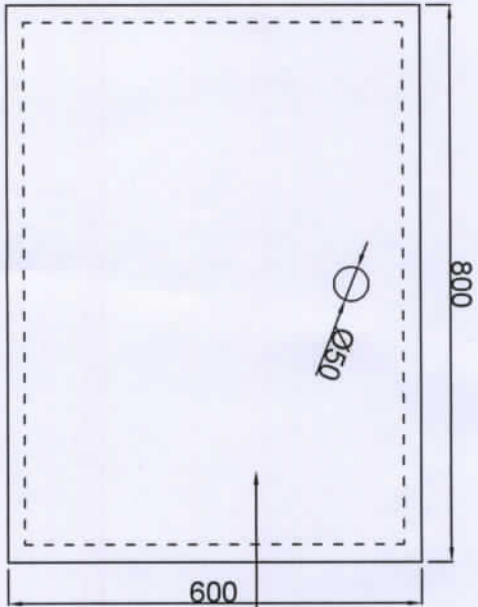

PLAN VIEW

COFFEE MAKER TABLE

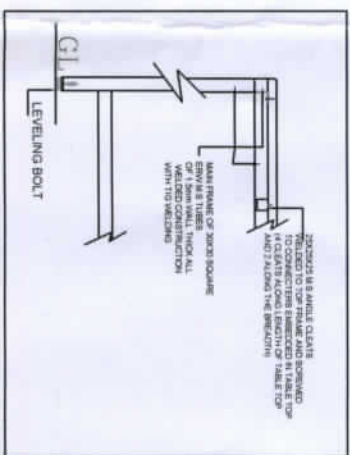
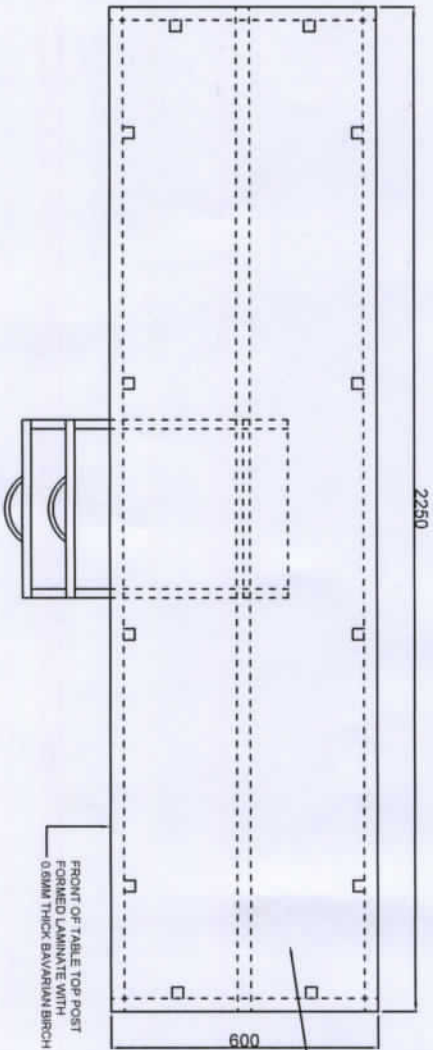
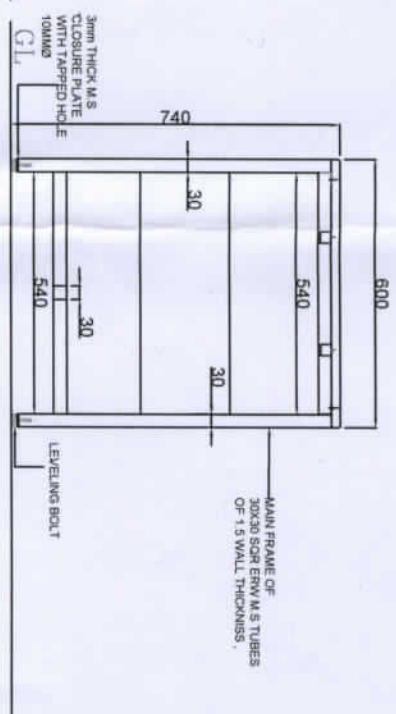
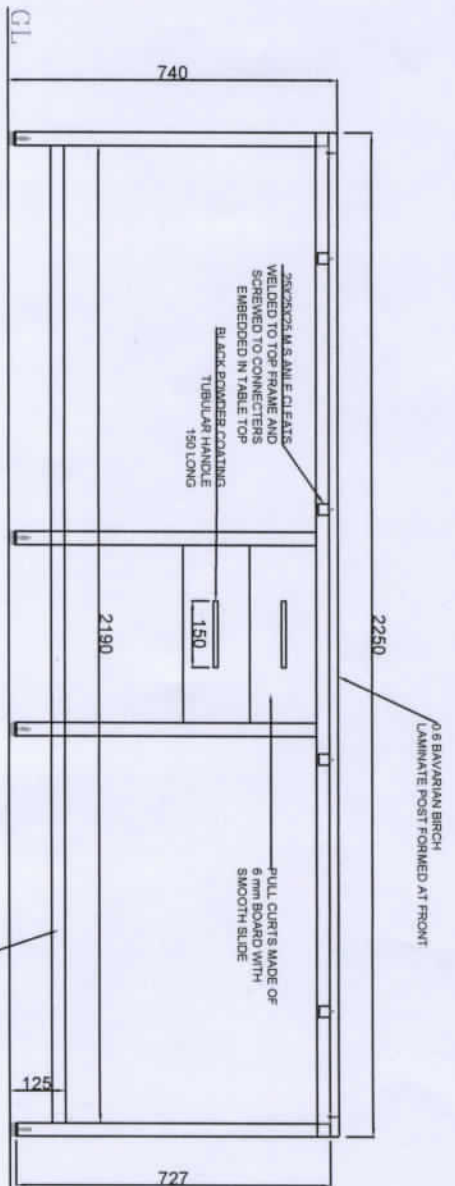

# WRITING TABLE

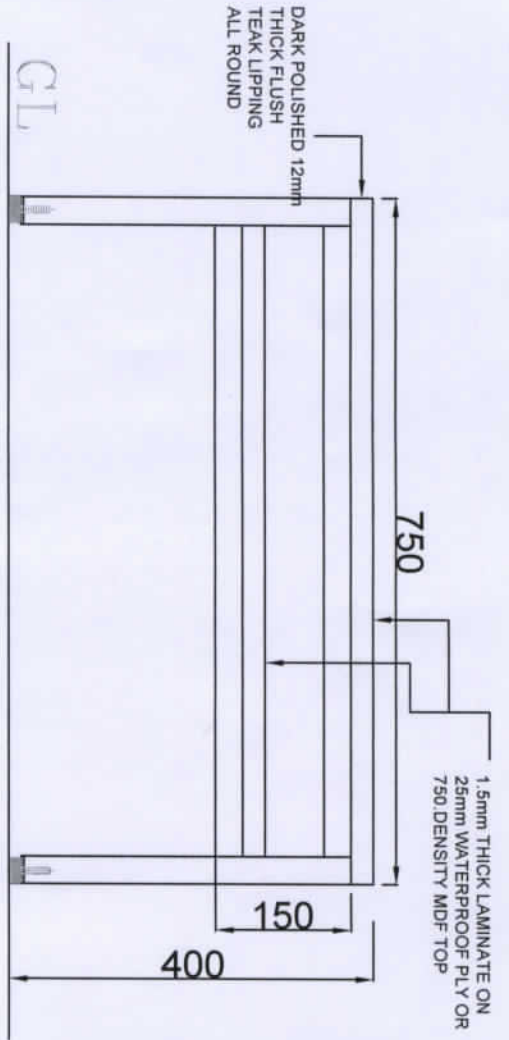

ELEVATION VIEW

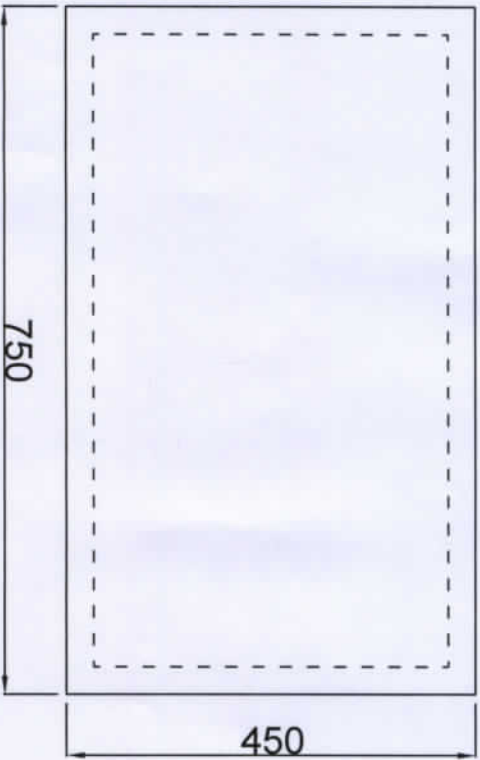

PLAN VIEW

CENTER TABLE

GL

ELEVATION VIEW

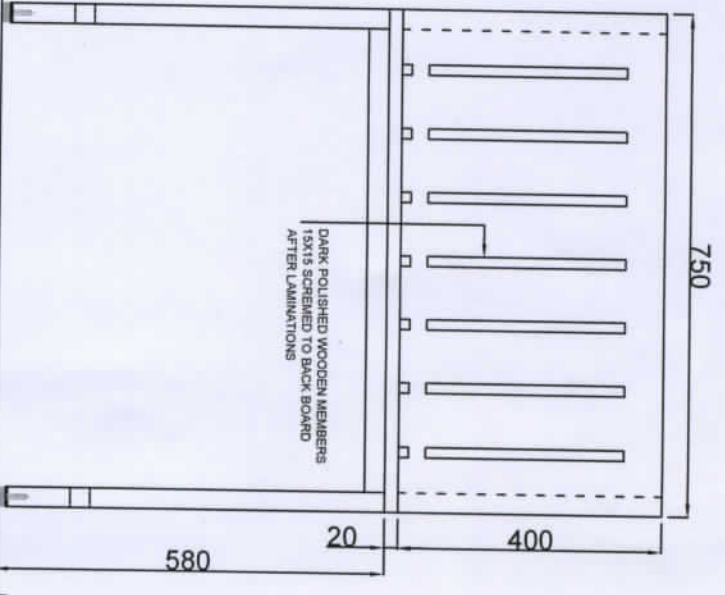

GL

END VIEW

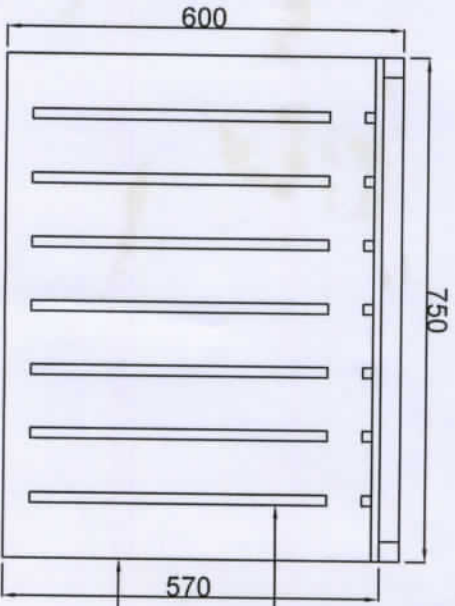
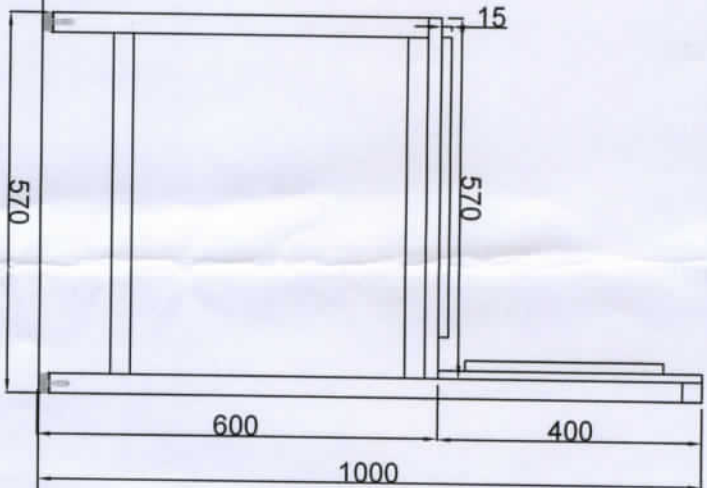

PLAN VIEW

TABLE 20 THICK BOARD WITH  
YELLOW LAMINATE

RACK TABLE TOP WILL  
HAVE SIMILAR STRIPS

# LUGGAGE RACK